

ST 072S | 스키드형

체인 내부 단면 치수

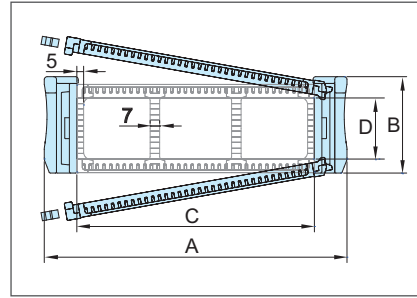
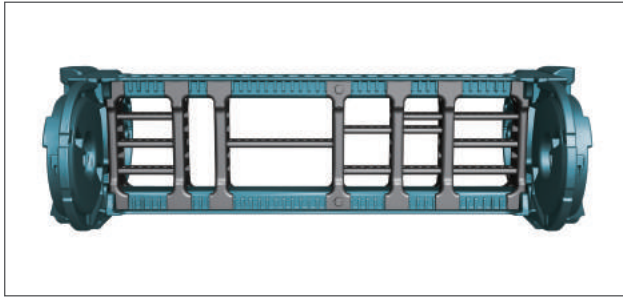

체인 타입	A 외부넓이	B 외부높이	C 프레임	D 내부높이	중 량 kg/m
ST 072S	105	71.8	50	45	2.48
	130		75		2.57
	155		100		2.67
	180		125		2.81
	195		140		2.89
	205		150		2.95
	220		165		3.02
	230		175		3.07
	245		190		3.32
	255		200		3.49
	295		240		3.81
	305		250		3.89
	355		300		4.23

(단위 : mm)

체인 치수

Ls: 스트로크

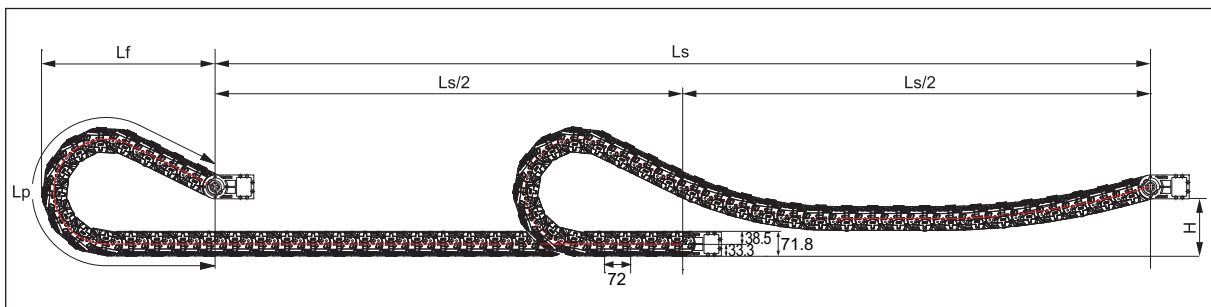

곡률반경 R	Lp 최소 곡률반경 길이	Lf 스트로크 초과 길이	H 이동 높이
100	806	380	180
120	917	420	
145	1,063	470	
200	1,400	580	
250	1,840	752	
300	2,280	924	

(단위 : mm)

엔드 브라켓 치수

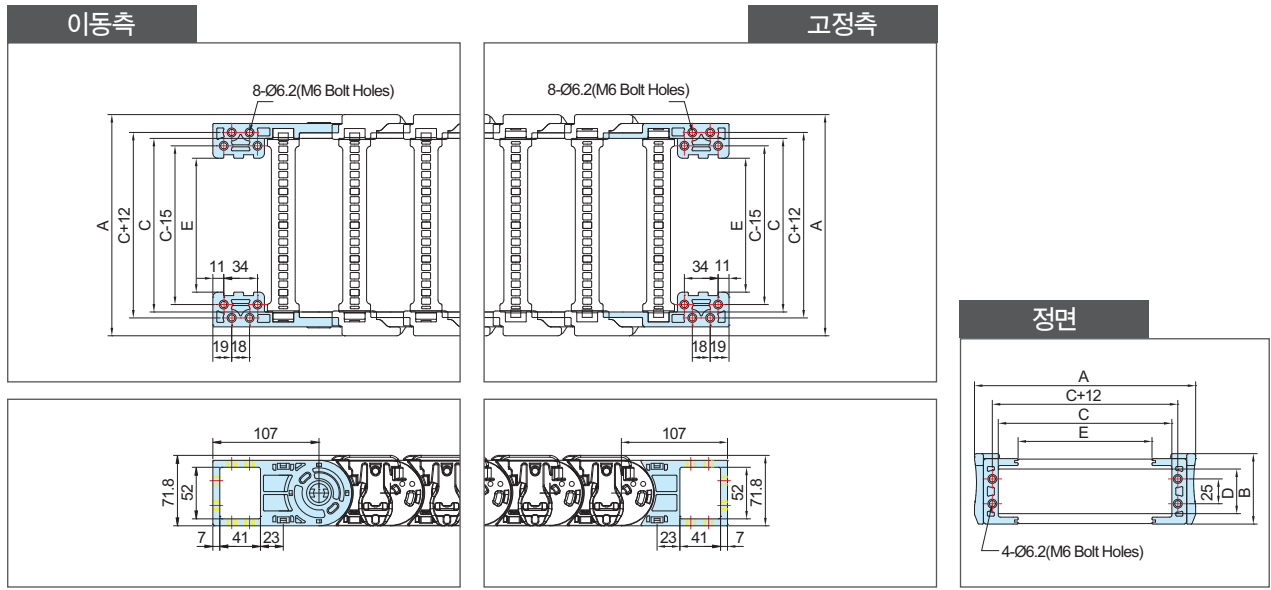

체인 타입	A 외부넓이	B 외부높이	C 프레임	D 내부높이	E M,EB 볼트홀 넓이	홀 치수
ST 072S	105	71.8	50	45	10	M6 볼트 홀
	130		75		35	
	155		100		60	
	180		125		85	
	195		140		100	
	205		150		110	
	220		165		125	
	230		175		135	
	245		190		150	
	255		200		160	
	295		240		200	
	305		250		210	
355	300	260				

(단위 : mm)

주문방법

ST 072S. 175. R200 / F - 10000L : 10ST



- 주문수량
- 체인길이
- 브라켓
- F : 다방면 취부 엔드 브라켓
- T : 타이랩
- S : 시스템 타이랩
- 곡률반경
- 내폭
- 장거리형(S)
- Shift Chain

디바이더 (DV)

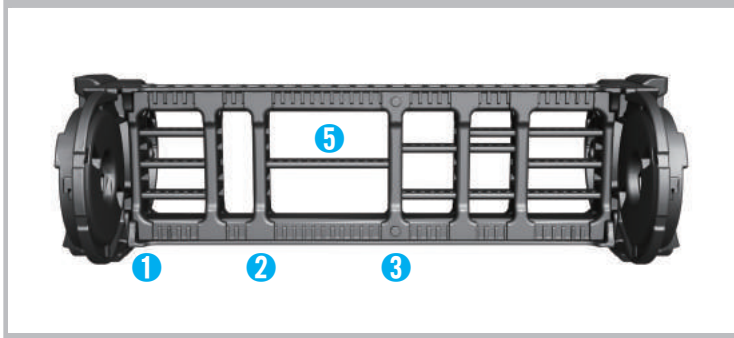

2링크마다 결합
 DV.T : 프레임 200~300 적용 (상하 프레임을 연결)
 DV.W : 시스템 타이랩 또는 FEB에 적용 가능

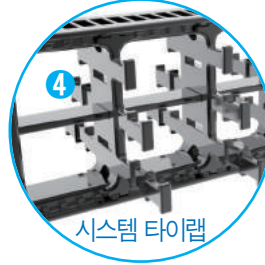

1 DV07.S

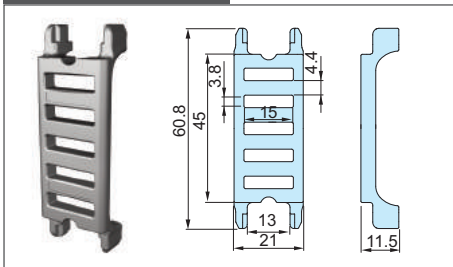

2 DV07.M

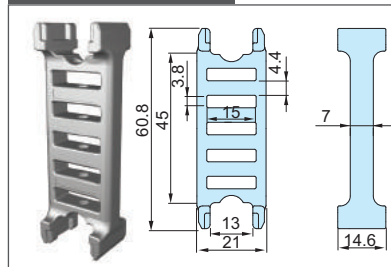

3 DV07.T

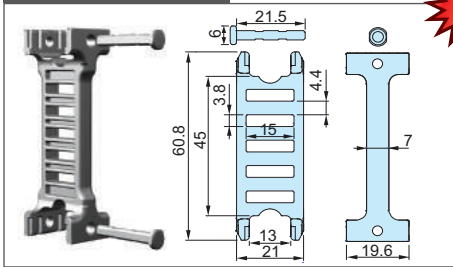

4 DV07.W

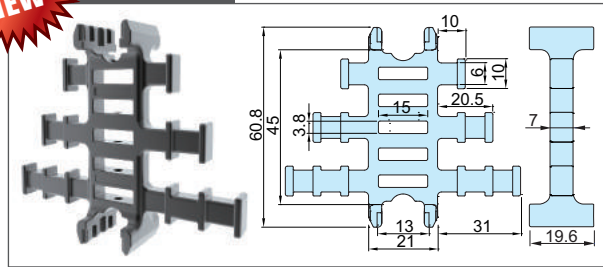

(단위 : mm)

세퍼레이터 (SP)

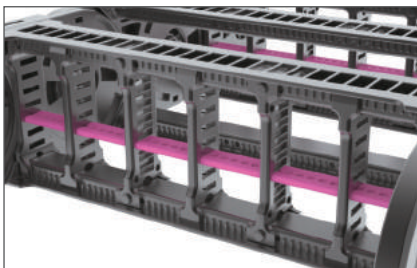

5 SP02 : 섹션 구성에 따라 길이 주문 가능

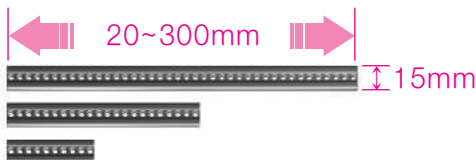

타이랩 (TW)

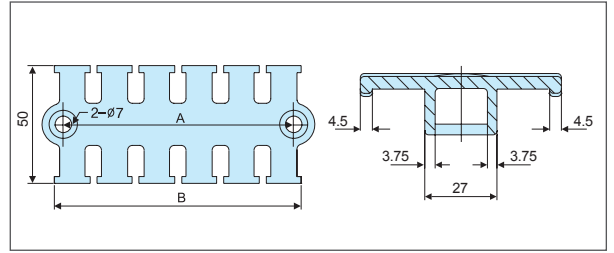
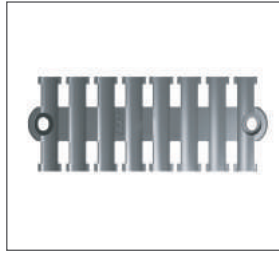
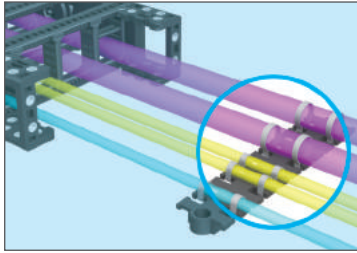

체인 타입	주문 품명	A	B
ST 072S	TW05.050	58	65
	TW05.075	75	82
	TW05.100	98	105
	TW05.125	122	129
	TW05.150	141	148

(단위 : mm)

시스템 타이랩 (STW)

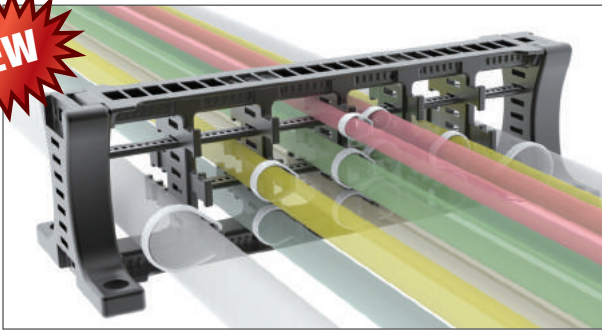

세퍼레이터와 디바이더는 프레임 크기 및 사이드밴드 사이즈에 따라 달라짐.

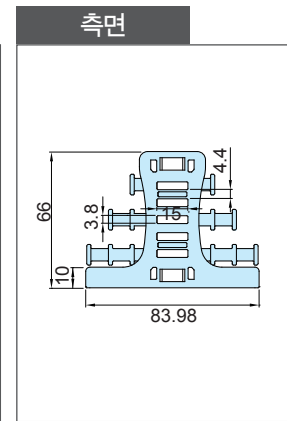
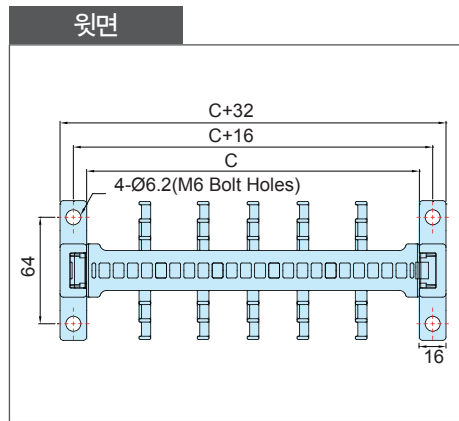
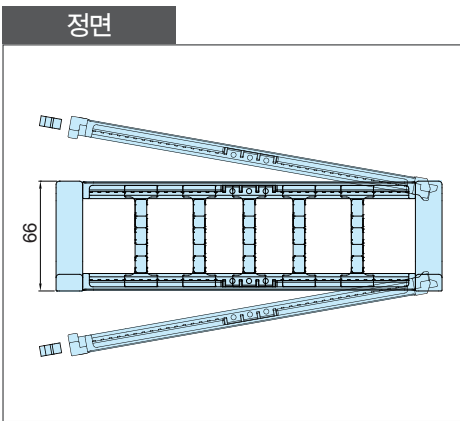

체인 타입	주문 품명	C 프레임	홀 치수
ST 072S	STW03.050	50	M6 볼트 홀
	STW03.075	75	
	STW03.100	100	
	STW03.125	125	
	STW03.140	140	
	STW03.150	150	
	STW03.165	165	
	STW03.175	175	
	STW03.190	190	
	STW03.200	200	
	STW03.240	240	
	STW03.250	250	
	STW03.300	300	

(단위 : mm)

