

ST 095S | 스키드형

체인 내부 단면 치수

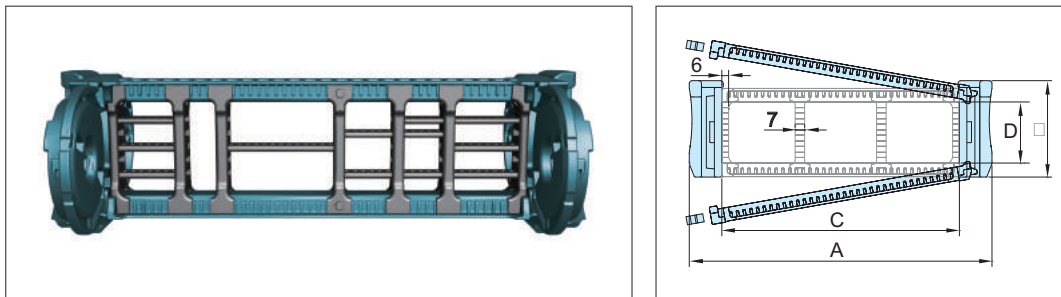

체인 타입	A 외부넓이	B 외부높이	C 프레임	D 내부높이	중 량 kg/m
ST 095S	137	89	75	56	3.44
	162		100		3.50
	187		125		3.68
	212		150		3.79
	237		175		3.92
	252		190		4.03
	262		200		4.10
	302		240		4.31
	312		250		4.36
	362		300		4.63
412	350	4.98			
462	400	5.38			

(단위 : mm)

체인 치수

Ls: 스트로크

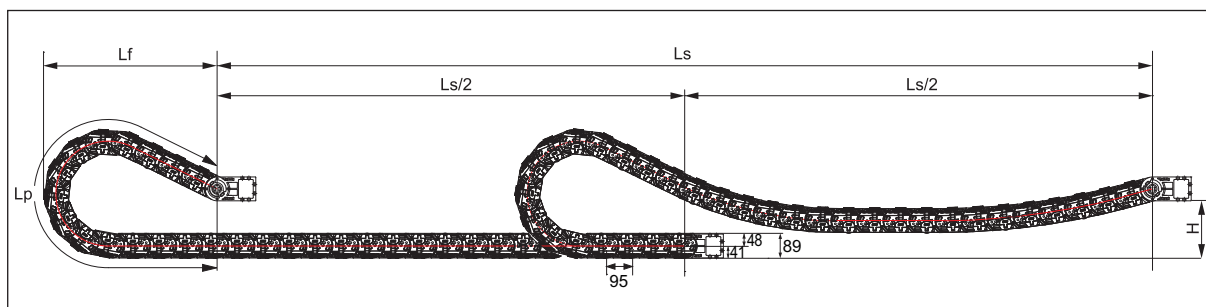

곡률반경 R	Lp 최소 곡률반경 길이	Lf 스트로크 초과 길이	H 이동 높이
135	1,091	504	210
150	1,178	534	
200	1,479	634	
230	1,666	694	
280	2,146	889	
400	3,232	1,319	

(단위 : mm)

엔드 브라켓 치수

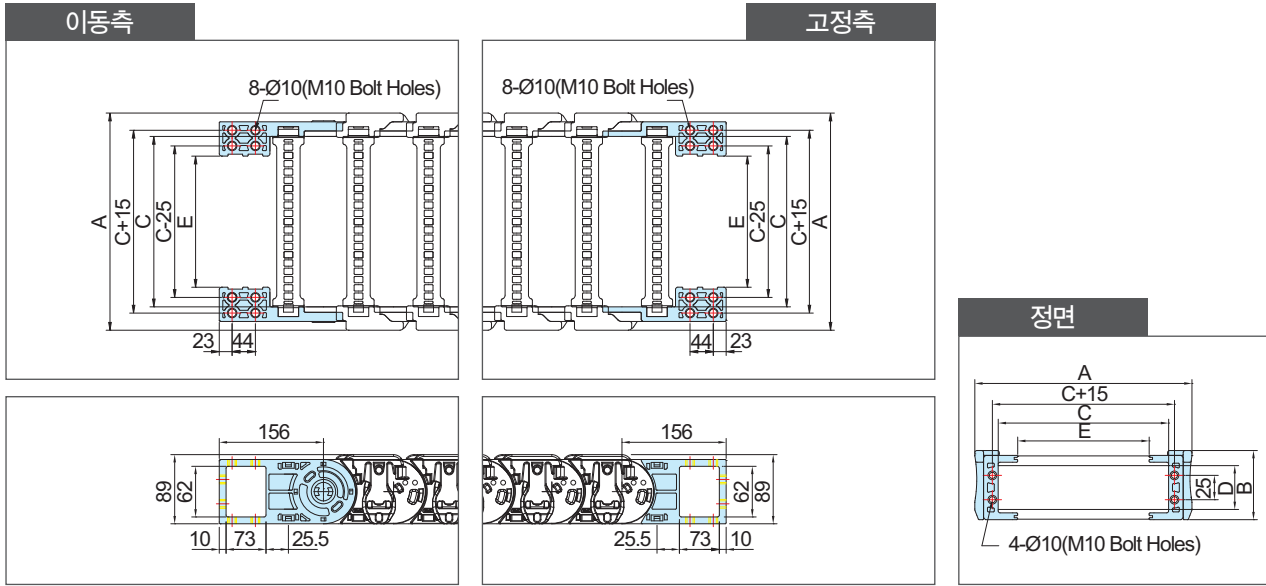

체인 타입	A 외부넓이	B 외부높이	C 프레임	D 내부높이	E M,EB 볼트홀 넓이	홀 치수
ST 095S	137	89	75	56	24	M10 볼트 홀
	162		100		49	
	187		125		74	
	212		150		99	
	237		175		124	
	252		190		139	
	262		200		149	
	302		240		189	
	312		250		199	
	362		300		249	
	412		350		299	
462	400	349				

(단위 : mm)

주문방법

ST 095S. 200. R200 / F - 10000L : 10ST



- 주문수량
- 체인길이
- 브라켓
- F : 다방면 취부 엔드 브라켓
- T : 타이랩
- S : 시스템 타이랩
- 곡률반경
- 내폭
- 장거리형(S)
- Shift Chain

디바이더 (DV)

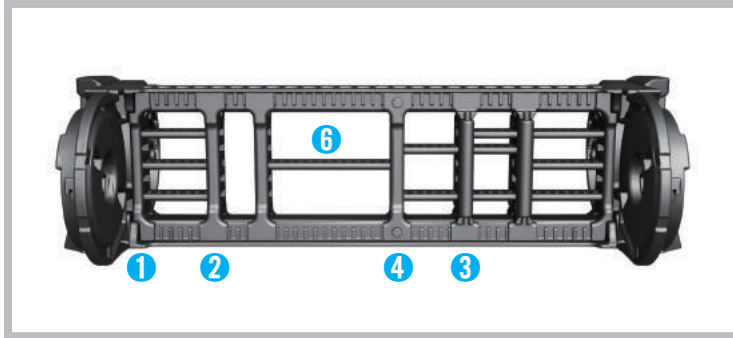

2링크마다 결합
 DV.T : 프레임 250~400 적용 (상하 프레임을 연결)
 DV.W : 시스템 타이랩 또는 FEB에 적용 가능

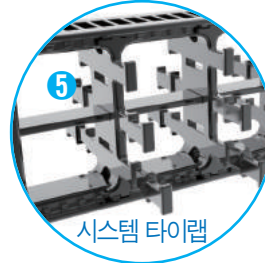

① DV09.S

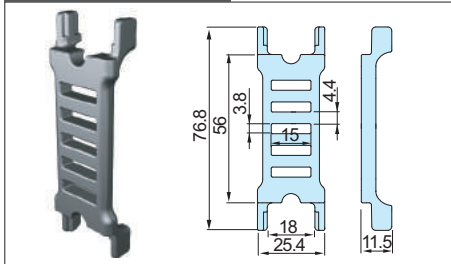

② DV09.M

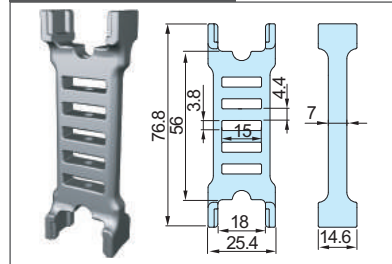

③ DV09.R

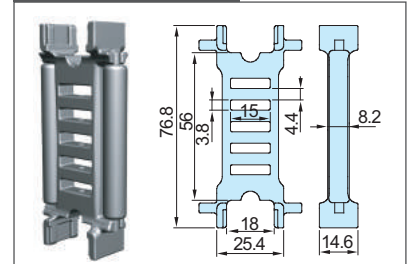

④ DV09.T

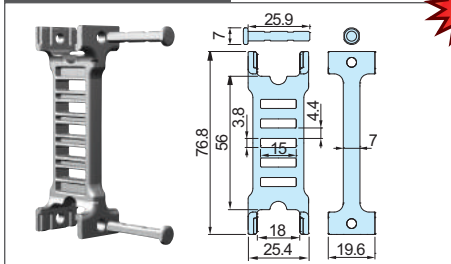

⑤ DV09.W

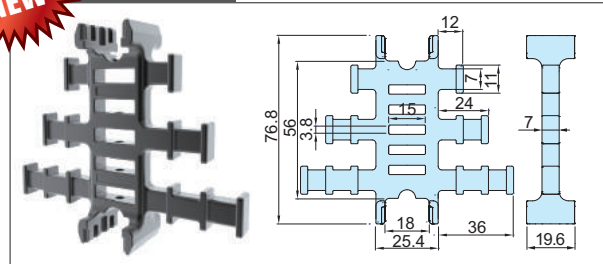

(단위 : mm)

세퍼레이터 (SP)

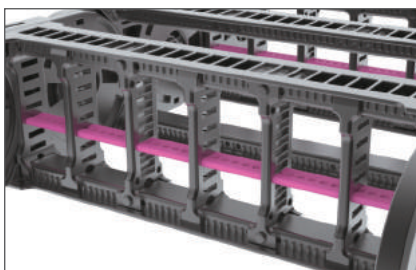

⑥ SP02 : 섹션 구성에 따라 길이 주문 가능

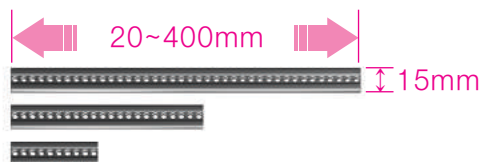

타이랩 (TW)

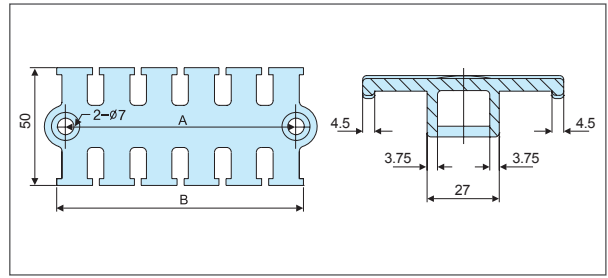
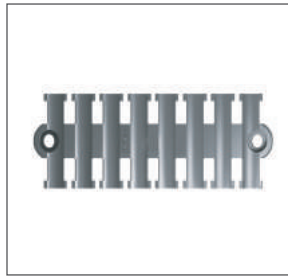
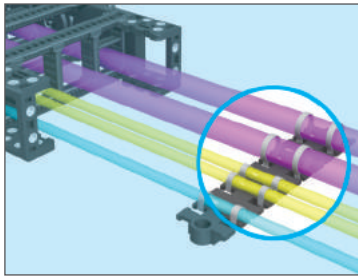

체인 타입	주문 품명	A	B
ST 095S	TW05.050	58	65
	TW05.075	75	82
	TW05.100	98	105
	TW05.125	122	129
	TW05.150	141	148

(단위 : mm)

시스템 타이랩 (STW)

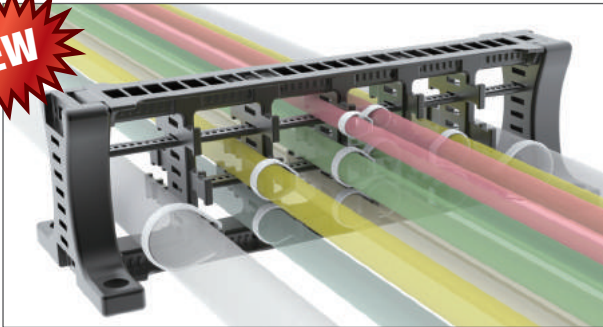

세퍼레이터와 디바이더는 프레임 크기 및 입선 케이블(호스) 사이즈에 따라 달라짐.

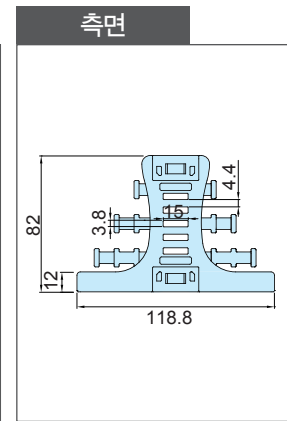
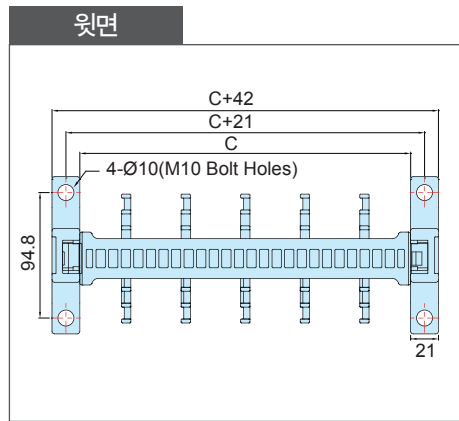
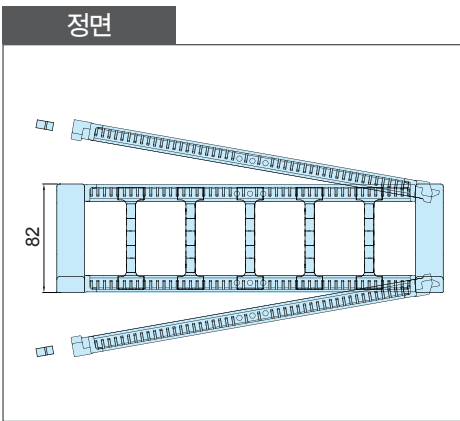

체인 타입	주문 품명	C 프레임	홀 치수
ST 095S	STW04.075	75	M10 볼트 홀
	STW04.100	100	
	STW04.125	125	
	STW04.150	150	
	STW04.175	175	
	STW04.190	190	
	STW04.200	200	
	STW04.240	240	
	STW04.250	250	
	STW04.300	300	
	STW04.350	350	
	STW04.400	400	

(단위 : mm)

가이드 잔넬

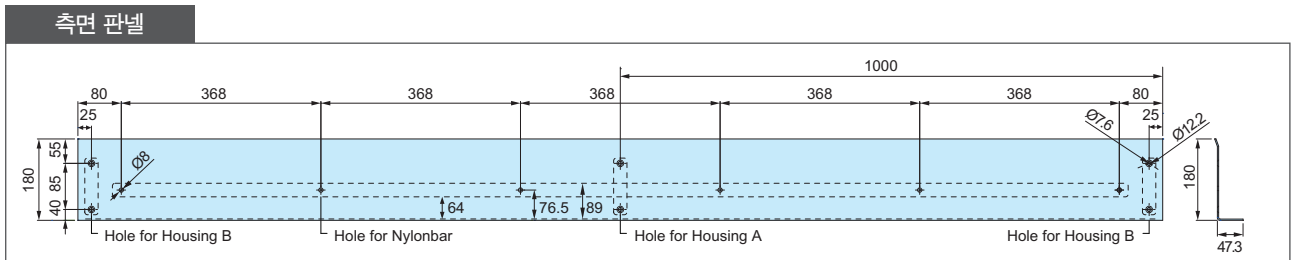
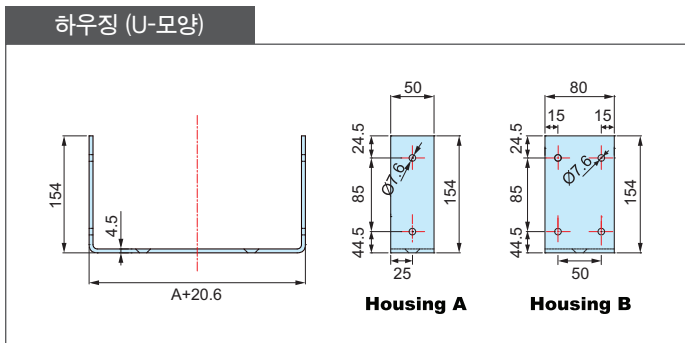
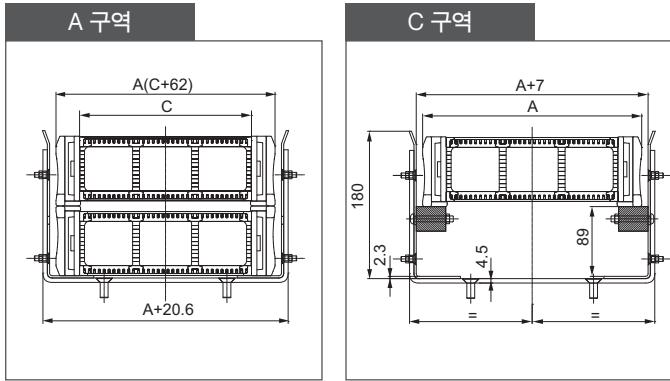

(단위 : mm)

가이드잔넬 주문방법

ST-GCS 095S. 175 / A,C : 200M

