

ST 120S | 스키드형

체인 내부 단면 치수

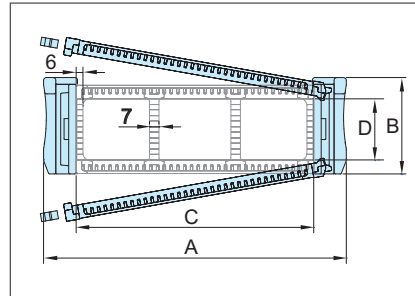
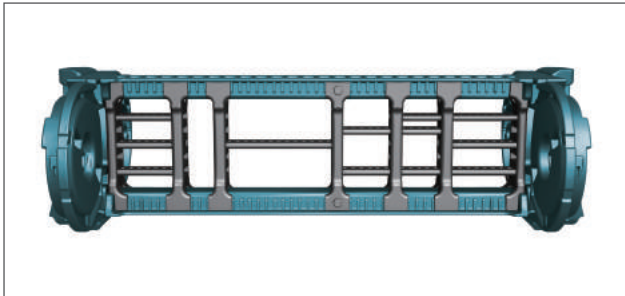

체인 타입	A 외부넓이	B 외부높이	C 프레임	D 내부높이	중량 kg/m
ST 120S	143	115	75	78	4.71
	168		100		4.83
	183		115		4.92
	193		125		4.98
	218		150		5.06
	243		175		5.24
	268		200		5.48
	308		240		5.72
	318		250		5.78
	358		290		6.12
	368		300		6.21
	418		350		6.63
	468		400		7.12
	518		450		7.38
568	500	7.61			
618	550	8.45			
668	600	8.61			

(단위 : mm)

체인 치수

Ls: 스트로크

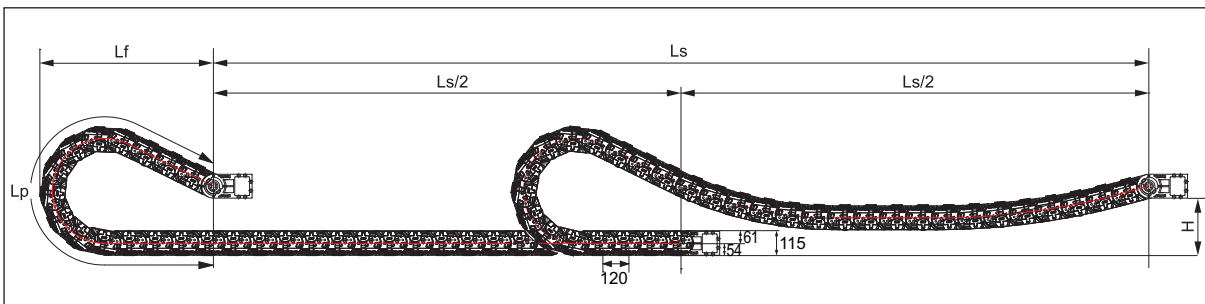

곡률반경 R	Lp 최소 곡률반경 길이	Lf 스트로크 초과 길이	H 이동 높이
180	1,441	654	260
200	1,559	694	
250	1,864	794	
300	2,178	894	
350	2,701	1,114	
400	3,225	1,334	
500	4,062	1,654	

(단위 : mm)

↻ 엔드 브라켓 치수

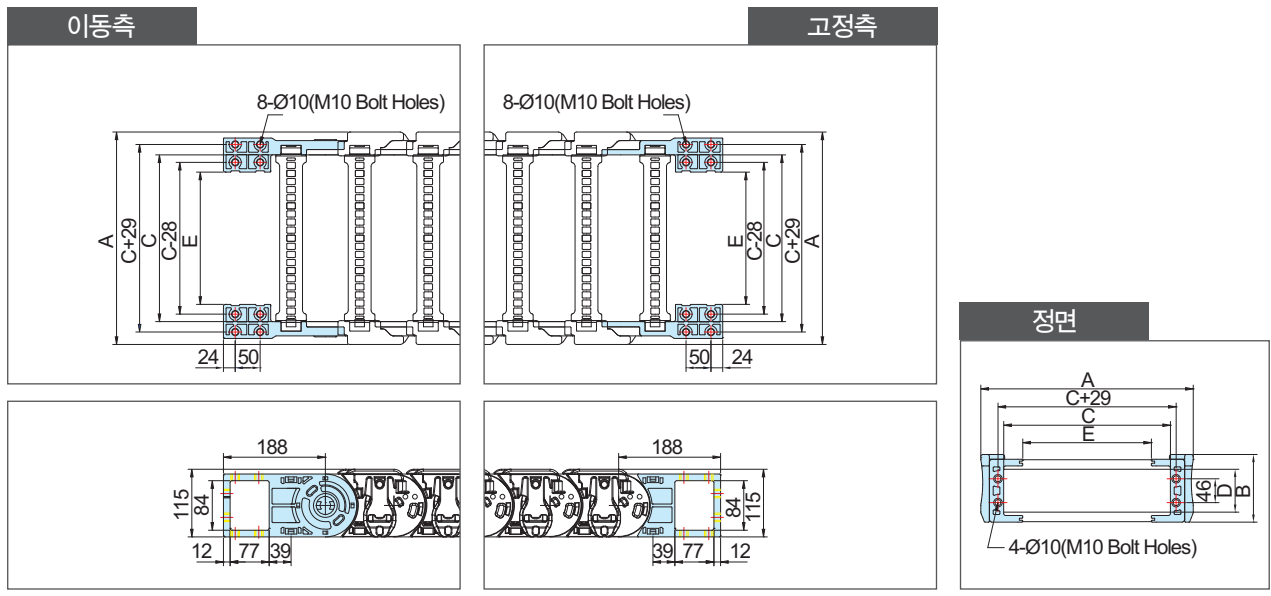

체인 타입	A 외부넓이	B 외부높이	C 프레임	D 내부높이	E M,EB 볼트홀 넓이	홀 치수
ST 120S	143	115	75	78	15	M10 볼트 홀
	168		100			
	183		115			
	193		125			
	218		150			
	243		175			
	268		200			
	308		240			
	318		250			
	358		290			
	368		300			
	418		350			
	468		400			
	518		450			
	568		500			
618	550					
668	600					

(단위 : mm)

↻ 주문방법

ST 120S. 300. R200 / F - 10000L : 10ST

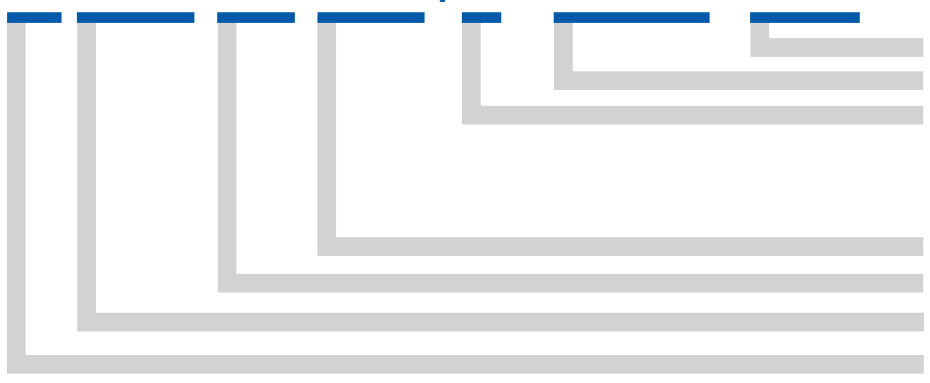

- 주문수량
- 체인길이
- 브라켓
- F : 다방면 취부 엔드 브라켓
- T : 타이랩
- S : 시스템 타이랩
- 곡률반경
- 내폭
- 장거리형(S)
- Shift Chain

디바이더 (DV)

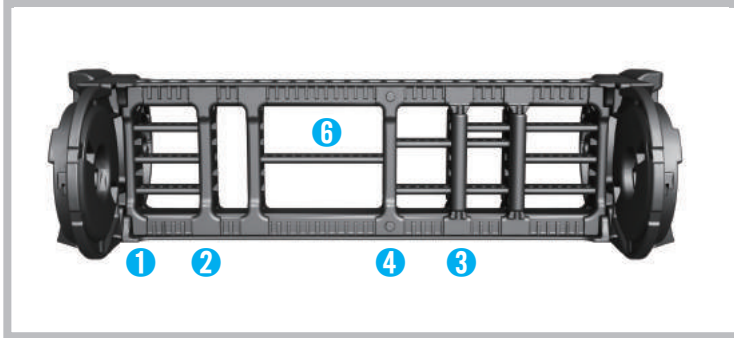

2링크마다 결합

DV.T : 프레임 300~600 적용 (상하 프레임을 연결)

DV.W : 시스템 타이랩 또는 FEB에 적용 가능

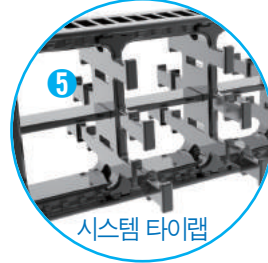

1 DV10.S

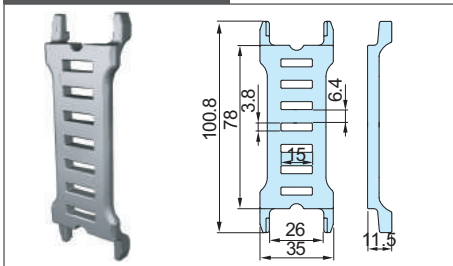

2 DV10.M

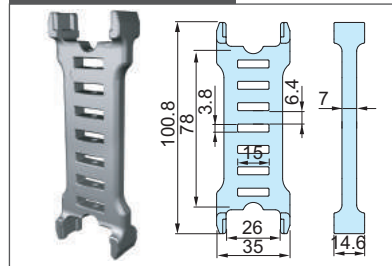

3 DV10.R

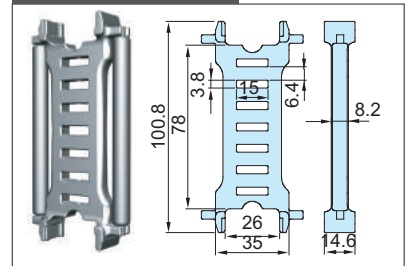

4 DV10.T

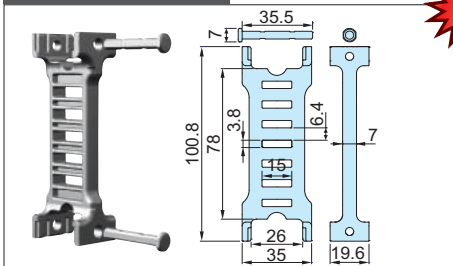

5 DV10.W

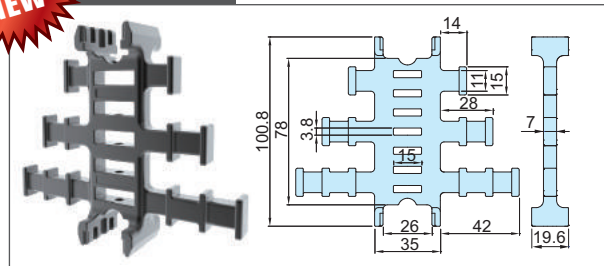

(단위 : mm)

세퍼레이터 (SP)

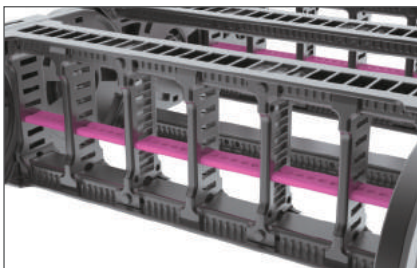

6 SP02 : 섹션 구성에 따라 길이 주문 가능

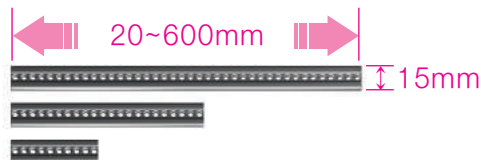

타이랩 (TW)

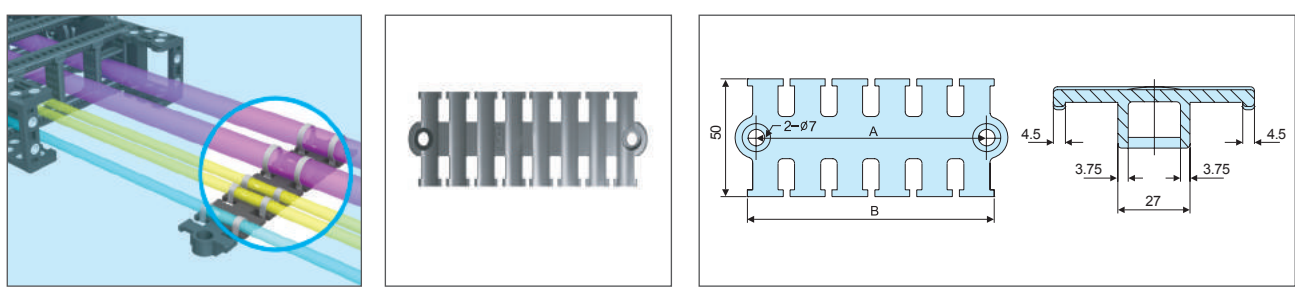

체인 타입	주문 품명	A	B
ST 120S	TW05.050	58	65
	TW05.075	75	82
	TW05.100	98	105
	TW05.125	122	129
	TW05.150	141	148

(단위 : mm)

시스템 타이랩 (STW)

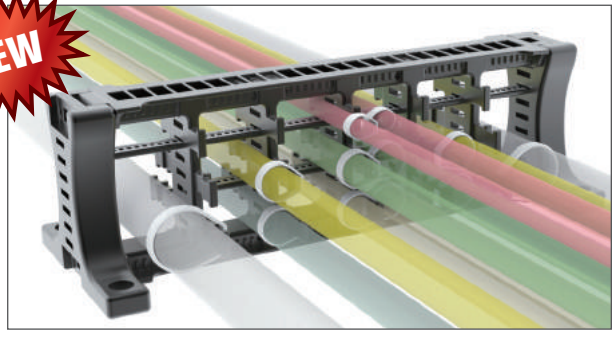

세퍼레이터와 디바이더는 프레임 크기 및 입선 케이블(호스) 사이즈에 따라 달라짐.

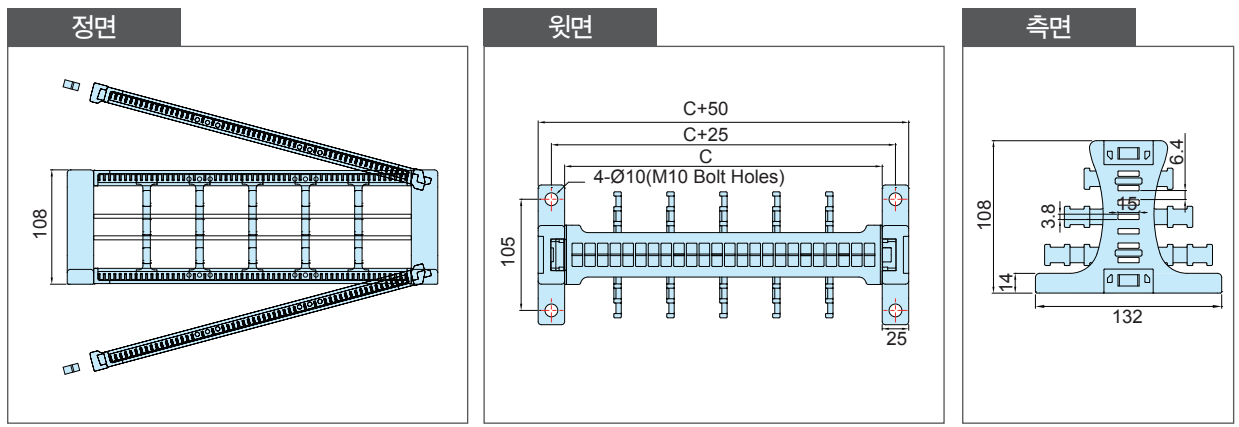

체인 타입	주문 품명	C 프레임	홀 치수
ST 120S	STW05.075	75	M10 볼트 홀
	STW05.100	100	
	STW05.115	115	
	STW05.125	125	
	STW05.150	150	
	STW05.175	175	
	STW05.200	200	
	STW05.240	240	
	STW05.250	250	
	STW05.290	290	
	STW05.300	300	
	STW05.350	350	
	STW05.400	400	
	STW05.450	450	
	STW05.500	500	
	STW05.550	550	
	STW05.600	600	

(단위 : mm)

가이드 잔넬

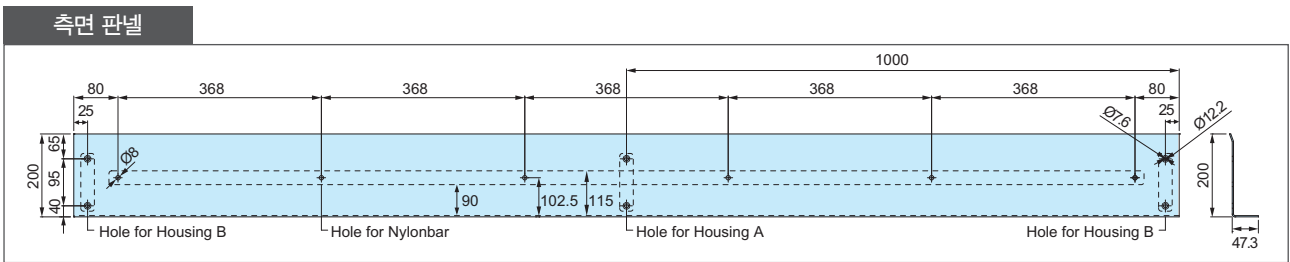
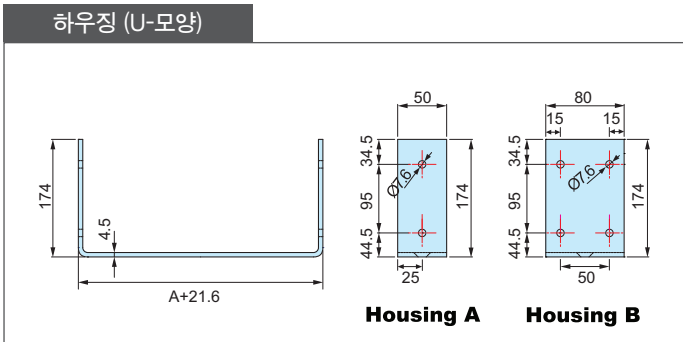
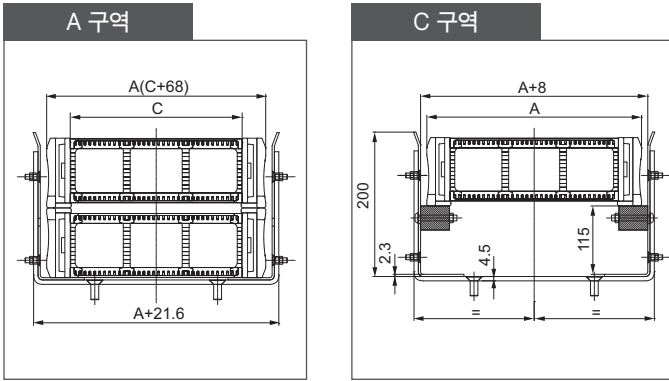

(단위 : mm)

가이드잔넬 주문방법

ST-GCS 120S. 175 / A,C : 200M

